



**1300 Sumner Avenue
Cleveland, Ohio 44115-2851
Phone: 216-241-7333 • Fax: 216-241-0105
E-mail: dasma@dasma.com**

Standard Rolling Door Architectural Details

In order for architects, engineers and specifiers to accurately include upward acting rolling door products such as service doors, counter shutters, grilles and fire doors in building plans and specifications, DASMA has developed a set of standard rolling door architectural details.

In addition to forwarding this information to various parties that are responsible for inclusion of such details into plans and specifications, the details are also intended to be incorporated into various nationally recognized publications that include standard architectural building products details.

DASMA's standard rolling door architectural details include the array of products most commonly specified, accurate depictions of these products, and details associated with these products including dimensional parameters, product application recommendations, and associated conditions and limitations.

Note: Technical Data Sheets are information tools only and should not be used as substitutes for instructions from individual manufacturers. Always consult with individual manufacturers for specific recommendations for their products and check the applicable local regulations.

This Technical Data Sheet was prepared by the members of DASMA's Rolling Door Division Technical Committee. DASMA is a trade association comprising manufacturers of rolling doors, fire doors, grilles, counter shutters, sheet doors, and related products; upward-acting residential and commercial garage doors; operating devices for garage doors and gates, sensing devices, and electronic remote controls for garage doors and gate operators; as well as companies that manufacture or supply either raw materials or significant components used in the manufacture and installation of the Active Members' products.

ROLLING DOOR DIVISION
TECHNICAL DATA SHEET
#265

TYPICAL DOOR COMPONENTS

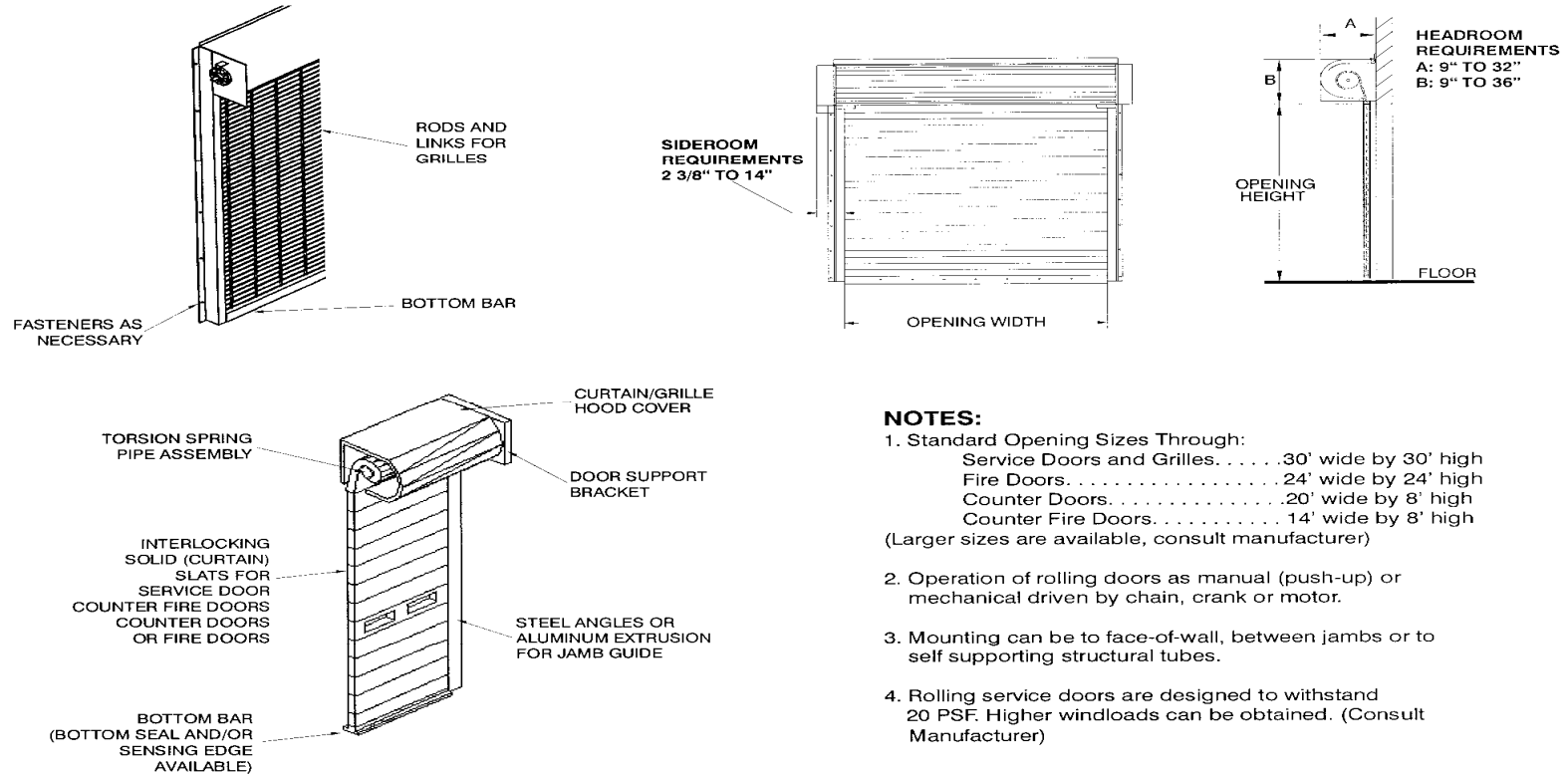

NOTES:

- Standard Opening Sizes Through:
 - Service Doors and Grilles. 30' wide by 30' high
 - Fire Doors. 24' wide by 24' high
 - Counter Doors. 20' wide by 8' high
 - Counter Fire Doors. 14' wide by 8' high
 (Larger sizes are available, consult manufacturer)
- Operation of rolling doors as manual (push-up) or mechanical driven by chain, crank or motor.
- Mounting can be to face-of-wall, between jambs or to self supporting structural tubes.
- Rolling service doors are designed to withstand 20 PSF. Higher windloads can be obtained. (Consult Manufacturer)

Note: Technical Data Sheets are information tools only and should not be used as substitutes for instructions from individual manufacturers. Always consult with individual manufacturers for specific recommendations for their products and check the applicable local regulations.

This Technical Data Sheet was prepared by the members of DASMA's Rolling Door Division Technical Committee. DASMA is a trade association comprising manufacturers of rolling doors, fire doors, grilles, counter shutters, sheet doors, and related products; upward-acting residential and commercial garage doors; operating devices for garage doors and gates, sensing devices, and electronic remote controls for garage doors and gate operators; as well as companies that manufacture or supply either raw materials or significant components used in the manufacture and installation of the Active Members' products.

ROLLING DOOR DIVISION
TECHNICAL DATA SHEET
#265

CURTAIN SLAT TYPES

STANDARD FLAT

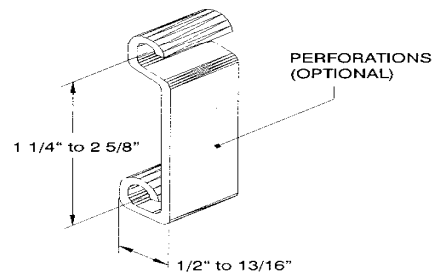

CURVED PROFILE

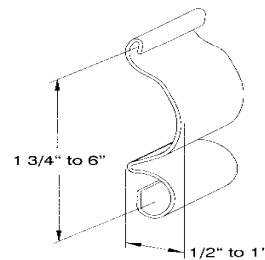

**EXTRUDED ALUMINUM
(FOR USE WITH ROLLING
COUNTER DOORS)**

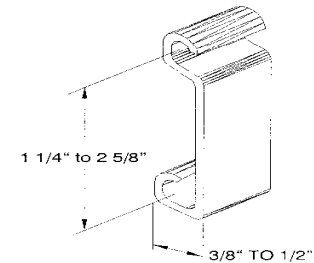

INSULATED

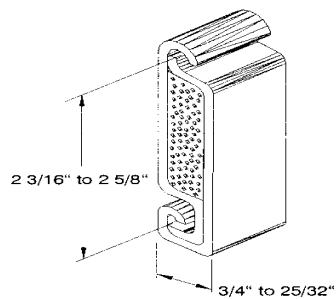

**WOOD (COUNTER
DOOR ONLY)**

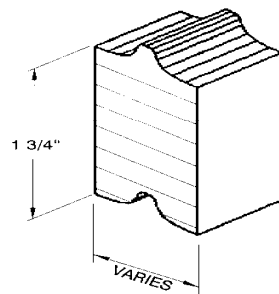

NOTES:

1. Solid curtain slats are made of 26 gauge to 16 gauge roll formed steel prime painted, galvanized steel, stainless steel, or 18 BDS to 16 BDS aluminum (mill or anodized).
2. Vision slats or panels may be inserted within standard slats for light transmission and visibility.
3. Optional perforated slats offer airflow, visibility and security.
4. Special curtain coatings are available including: epoxy, polyester, finish paint, powder coating, kynar™, etc. These coatings are available in many colors. Aluminum slats are available with various anodizing treatments.

Note: Technical Data Sheets are information tools only and should not be used as substitutes for instructions from individual manufacturers. Always consult with individual manufacturers for specific recommendations for their products and check the applicable local regulations.

This Technical Data Sheet was prepared by the members of DASMA's Rolling Door Division Technical Committee. DASMA is a trade association comprising manufacturers of rolling doors, fire doors, grilles, counter shutters, sheet doors, and related products; upward-acting residential and commercial garage doors; operating devices for garage doors and gates, sensing devices, and electronic remote controls for garage doors and gate operators; as well as companies that manufacture or supply either raw materials or significant components used in the manufacture and installation of the Active Members' products.

ROLLING DOOR DIVISION
TECHNICAL DATA SHEET
#265

ROLLING GRILLE CURTAIN TYPES/BOTTOM BAR TYPES

ROLLING GRILLE CURTAIN TYPES

STRAIGHT PATTERN

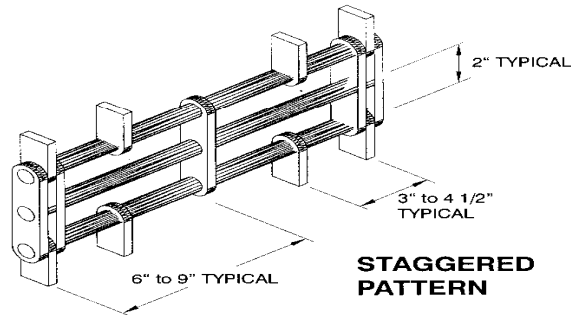
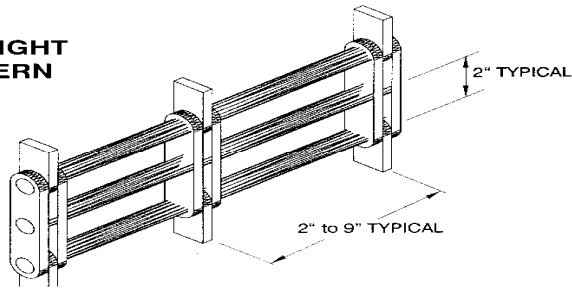

NOTES:

1. Grilles are made from galvanized steel, stainless steel or aluminum rods and links laced together to make the curtain.
2. Grilles are also available as manually operated folding type with overhead track. Some curtains fold up horizontally into a wall pocket. Consult manufacturer.

BOTTOM BARS

DOUBLE ANGLE

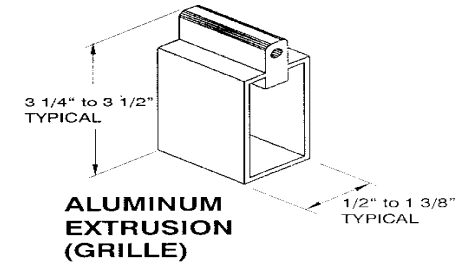
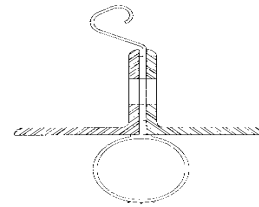

ALUMINUM EXTRUSION (GRILLE)

NOTES:

1. Angle bars are used mostly for service and fire doors. Finishes include prime painted steel, galvanized steel or stainless steel. Sizes vary by door size.
2. Aluminum extrusion bars standard for grilles and some counter doors and service doors.
3. Optional electric and pneumatic sensing edges are used to stop and reverse motor operated doors if they hit an obstruction while closing.
4. Many locking options are available.

Note: Technical Data Sheets are information tools only and should not be used as substitutes for instructions from individual manufacturers. Always consult with individual manufacturers for specific recommendations for their products and check the applicable local regulations.

This Technical Data Sheet was prepared by the members of DASMA's Rolling Door Division Technical Committee. DASMA is a trade association comprising manufacturers of rolling doors, fire doors, grilles, counter shutters, sheet doors, and related products; upward-acting residential and commercial garage doors; operating devices for garage doors and gates, sensing devices, and electronic remote controls for garage doors and gate operators; as well as companies that manufacture or supply either raw materials or significant components used in the manufacture and installation of the Active Members' products.

ROLLING DOOR DIVISION
TECHNICAL DATA SHEET
#265

GUIDE DETAILS (VARY AMONG MANUFACTURERS)

SERVICE & FIRE DOORS

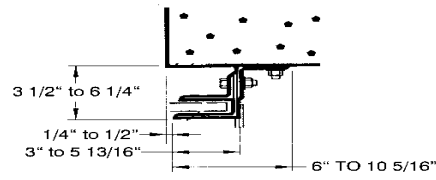

**MASONRY
FACE OF WALL
MOUNTING**

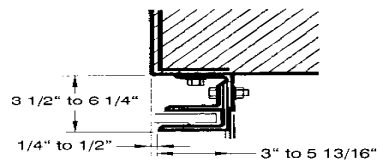

**STEEL
FACE OF WALL
MOUNTING**

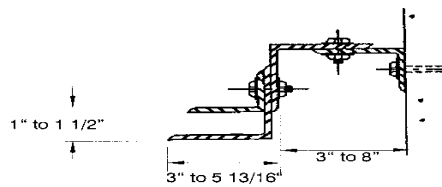

**STEEL OR MASONRY
BETWEEN JAMBS
MOUNTING**

GRILLES

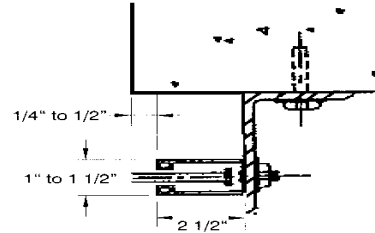

**STEEL OR MASONRY
FACE OF WALL
MOUNTING**

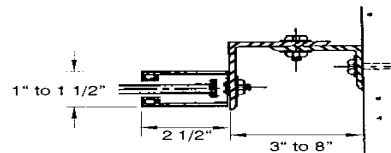

**STEEL OR MASONRY
BETWEEN JAMBS
MOUNTING**

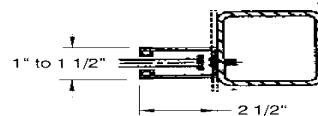

TUBE MOUNTED

COUNTER DOORS

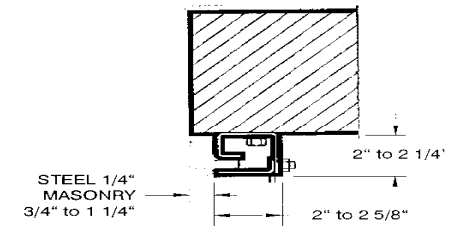

**STEEL OR MASONRY
FACE OF WALL
MOUNTING**

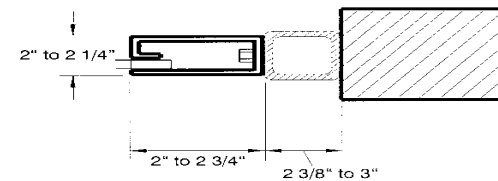

**STEEL OR MASONRY
BETWEEN JAMBS
MOUNTING**

Note: Technical Data Sheets are information tools only and should not be used as substitutes for instructions from individual manufacturers. Always consult with individual manufacturers for specific recommendations for their products and check the applicable local regulations.

This Technical Data Sheet was prepared by the members of DASMA's Rolling Door Division Technical Committee. DASMA is a trade association comprising manufacturers of rolling doors, fire doors, grilles, counter shutters, sheet doors, and related products; upward-acting residential and commercial garage doors; operating devices for garage doors and gates, sensing devices, and electronic remote controls for garage doors and gate operators; as well as companies that manufacture or supply either raw materials or significant components used in the manufacture and installation of the Active Members' products.